

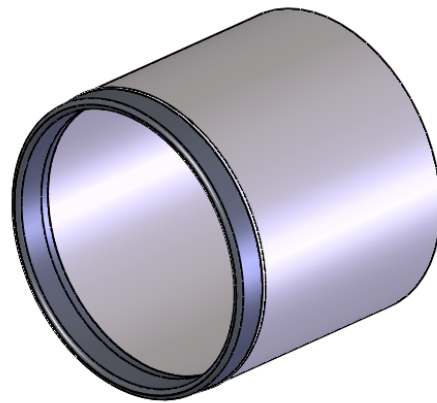

Phone: 1-800-678-0814 \ 1-503-287-9822 Fax: 1-800-287-7483 \ 1-503-287-7483

Versa-Steel, Inc.

Open End Cutting Shoe Data Sheet

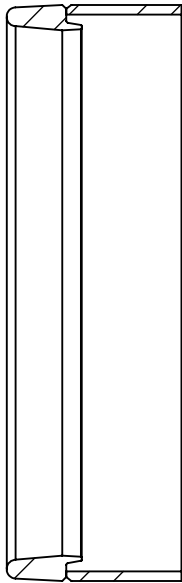

PROPRIETARY AND CONFIDENTIAL

THE INFORMATION CONTAINED IN THIS DRAWING IS THE SOLE PROPERTY OF VERSA-STEEL, INC. ANY REPRODUCTION IN PART OR AS A WHOLE WITHOUT THE WRITTEN PERMISSION OF VERSA-STEEL, INC. IS PROHIBITED.

SIZE	DWG. NO.	REV.
A Equipment Data Sheet		A
SCALE:1:10	WEIGHT:	SHEET 1 OF 3

Product Description

Both of our cutting shoes are easy to install with a slip-on fit. The design places the cross-sectional area directly below the wall of the pipe for maximum support during penetration. They are a more heavy duty construction than other brands.

The inside-fit cutting shoe has a weld prep built into the shoe. These tips are designed with a weld chamfer built into the casting. Slip shoe inside pipe and using a 70xx series rod weld a 5/16" or larger weld all around.

Like our inside-fit shoe, this shoe has a slip-on fit, and the cross-sectional area lies below the wall of the pipe. The outside fit cutting shoe has a natural fillet on top for easy welding. These slip fit shoes are easily attached with a 5/16" or larger fillet weld at the top of the flange. For best results, weld all around the shoe with a 70xx series rod.

Type Inside Fit

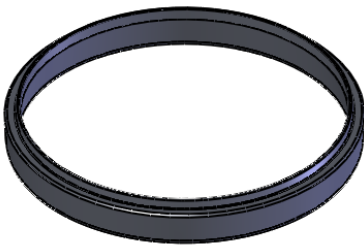

Type Outside Fit

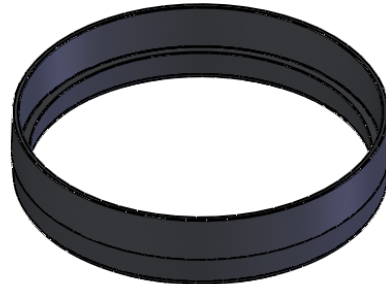

Versa Steel Open End Cutting Shoe and Pipe Cross-Section View

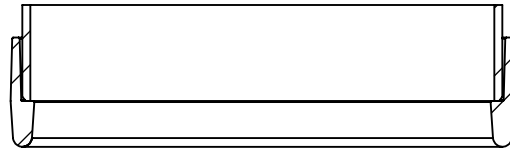
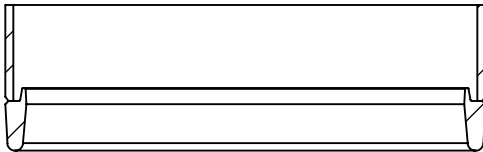

<p>PROPRIETARY AND CONFIDENTIAL</p> <p>THE INFORMATION CONTAINED IN THIS DRAWING IS THE SOLE PROPERTY OF VERSA-STEEL, INC. ANY REPRODUCTION IN PART OR AS A WHOLE WITHOUT THE WRITTEN PERMISSION OF VERSA-STEEL, INC. IS PROHIBITED.</p>			DIMENSIONS ARE IN INCHES TOLERANCES:		NAME	DATE	Description: Open End Cutting Shoes Part Number:		
			1/X ± 1/16"		DRAWN	JML		12/27/2007	
			.XX ± .01		CHECKED				
			.XXX ± .003		ENG APPR.				
			.XXXX ± .0005		MFG APPR.				
		MATERIAL	Steel Alloy		Q.A.		SCALE: 1:5 WEIGHT: SHEET 2 OF 3		
NEXT ASSY	USED ON	FINISH		COMMENTS:		SIZE		DWG. NO.	REV.
APPLICATION		DO NOT SCALE DRAWING				A		Equipment Data Sheet	A

Open End Cutting Shoes

Type Inside Fit

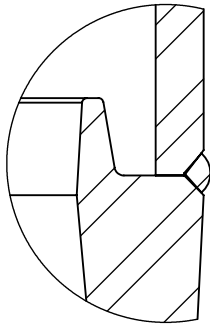

These tips are designed with a weld chamfer built into the casting. Slip shoe inside pipe and using a 70xx series rod weld a 5/16" or larger weld all around.

Type Outside Fit

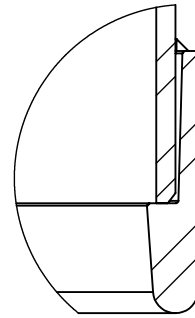

These slip fit shoes are easily attached with a 5/16" or larger fillet weld at the top of the flange. For best results, weld all around the shoe with a 70xx series rod.

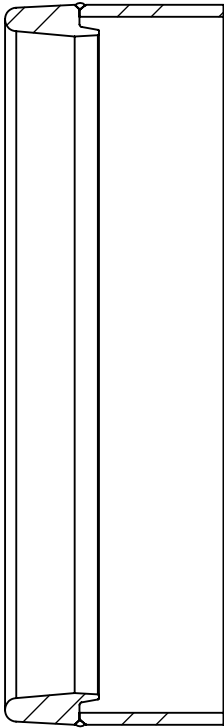

PROPRIETARY AND CONFIDENTIAL

THE INFORMATION CONTAINED IN THIS DRAWING IS THE SOLE PROPERTY OF VERSA-STEEL, INC. ANY REPRODUCTION IN PART OR AS A WHOLE WITHOUT THE WRITTEN PERMISSION OF VERSA-STEEL, INC. IS PROHIBITED.

		DIMENSIONS ARE IN INCHES TOLERANCES:		NAME	DATE	Description: Open End Cutting Shoes Part Number:	
		1/X ± 1/16"		DRAWN	JML		12/27/2007
		.XX ± .01		CHECKED			
		.XXX ± .003		ENG APPR.			
		.XXXX ± .0005		MFG APPR.			
		MATERIAL		Q.A.			
		Steel Alloy		COMMENTS:			
NEXT ASSY	USED ON	FINISH					
		None					
APPLICATION		DO NOT SCALE DRAWING					
				SIZE	DWG. NO.	REV.	
				A Equipment Data Sheet		A	
				SCALE:1:8	WEIGHT:	SHEET 3 OF 3	